

Planta de acabados

ESCALA 1:25

NOMENCLATURA	
▣	INDICIA ESTANDEZGO DE BLOQUE VERTICAL DE 15 X 20 X 0.40 Y 15 X 20 X 0.40 EN COLOMANA Y BLOQUE ENMA
▤	INDICIA ALISADO EN MARMOL Y UNO EN EL PASO
⬇	INDICIA ALISADO EN MARMOL EN EL PASO
⬆	INDICIA NIVEL DEL PASO
⬇	INDICIA NIVEL DEL PASO
PC	PISO DE CONCRETO AL SAO
BC	BANQUETA O RAMPA DE CONCRETO CURADO
V	INDICIA TIPO DE VENTANA
P	INDICIA TIPO DE PUERTA

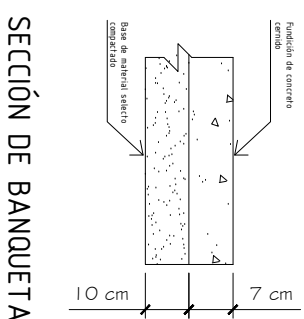
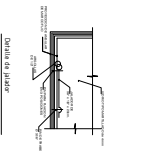
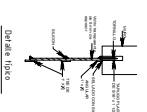
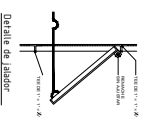
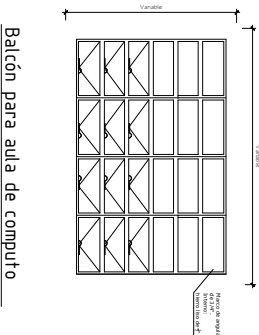
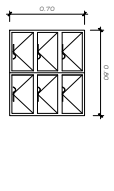
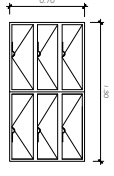
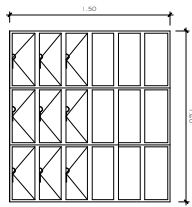
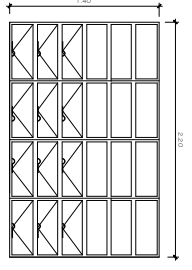
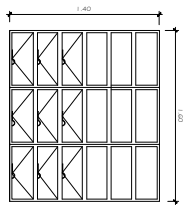
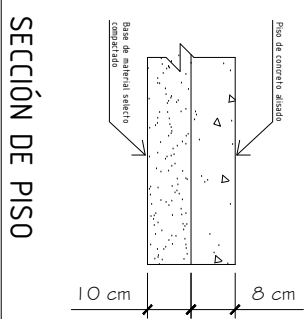
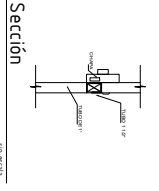
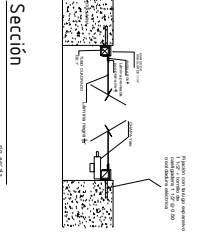
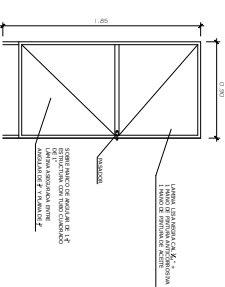
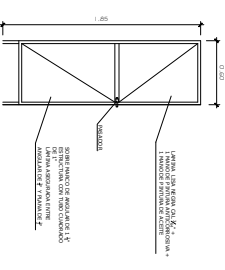
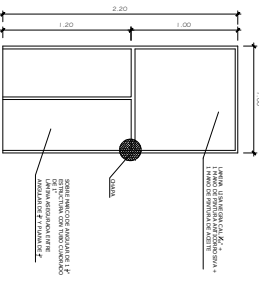
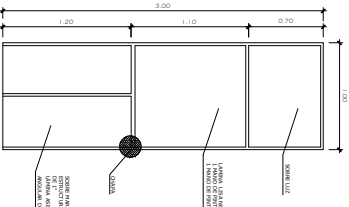

Vo. Bo. *[Signature]*

F.: *[Signature]*
 Angel Anibal Orzale Urzua
 Ingeniero Civil
 Colegiado No. 12,744

FECHA: abril de 2020
 ESCALA: INDICADA

CONTENIDO: Acabados
 UBICACION: Aldea Las Pacayas
 Uspantán, Quiché

PROYECTO:
 CONSTRUCCIÓN INSTITUTO BÁSICO ALDEA LAS PACAYAS

